

TRACY[®] lighting solution

SPECIFICATIONS

LED LBOND



www.ledibond.com
sales@ledibond.com
Made in Denmark

SPECIFICATIONS

TRACY® is an innovative linear and modular lighting solution with a market-leading lifespan. The lightweight and robust 6mm slim aluminum design enables multiple indoor and outdoor applications.



Set the light accordingly with most lighting control systems (DALI)

IP67

Robust and weather resistance making it perfect for outdoor applications

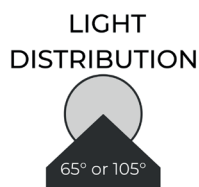

Securing light to be spread nicely on the floor too



Made for a sustainable world with energy saving LEDs and 96.6% product recyclability

NATURAL
WHITE
LIGHT

Nice light to create save and secure environments

50,000h



Market leading product lifespan for stability and minimal waste

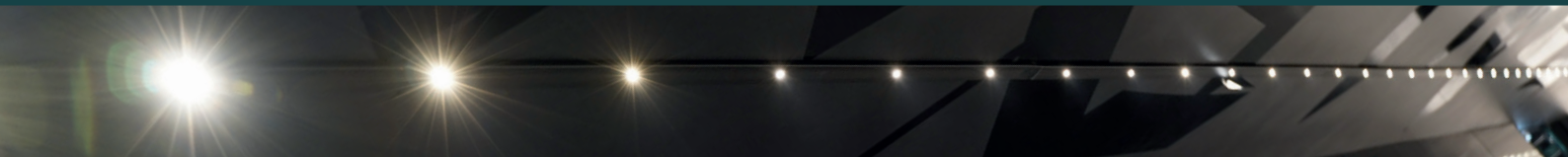

Overview

Technology	LED Technology
Material	Aluminium
Panel color	20 colors (anodized)
Height / width	6 mm / 40 mm
Panel length	300 mm - 1800 mm (up to 40 m connected)
IP	IP20 / IP67
Voltage	12 or 24 VDC
Power Consumption	1 W per LED spot (max 3,6 W)
Efficiency	Up to 193 lm/W*
Luminous flux	Max 550 lm per LED spot
Color rendering index	+70, +80, +90
Color Temperature	3000K, 4000K or 6500K (other on request)
RoHS compliant	Yes
REACH compliant	Yes
Dimmable	Yes
Designed and produced in	Denmark

* at 24 V, 6500K, CRI +70, 1 W per spot

SPECIFICATIONS

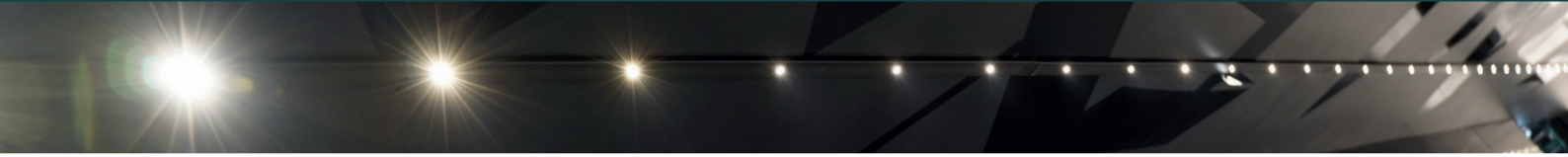

Order Codes

LED Panels Product Description Format

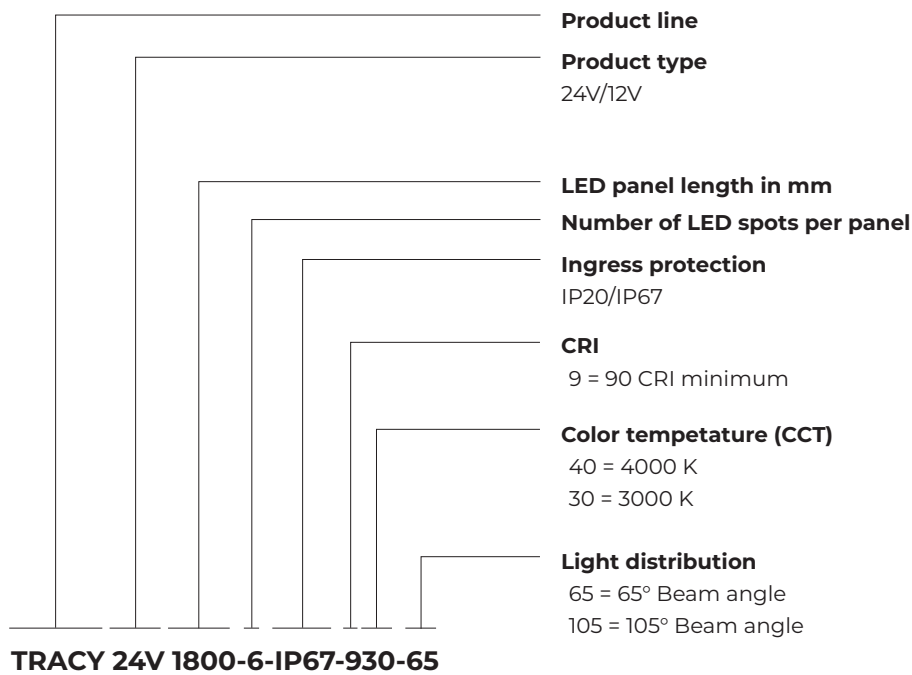

LED panels

Order code example: TRACY 24V 1800-6-IP67-930-65

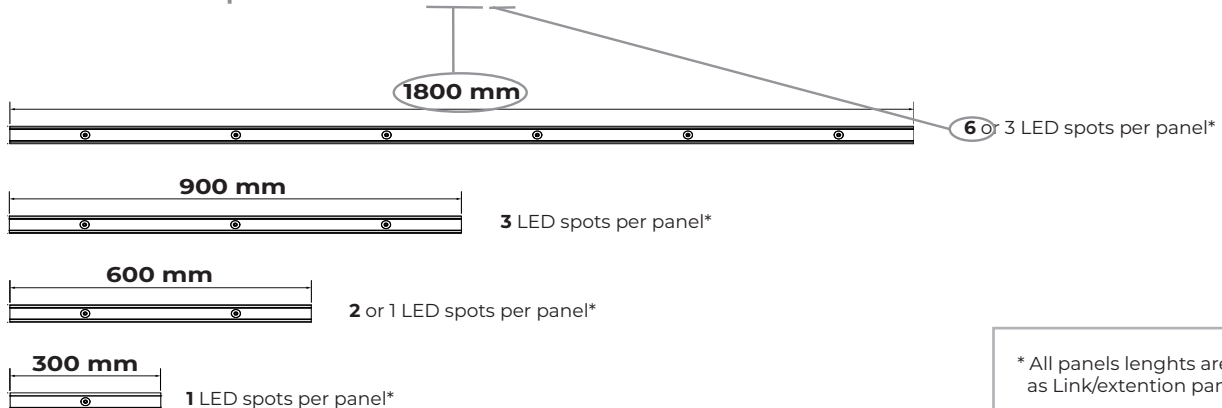

SPECIFICATIONS

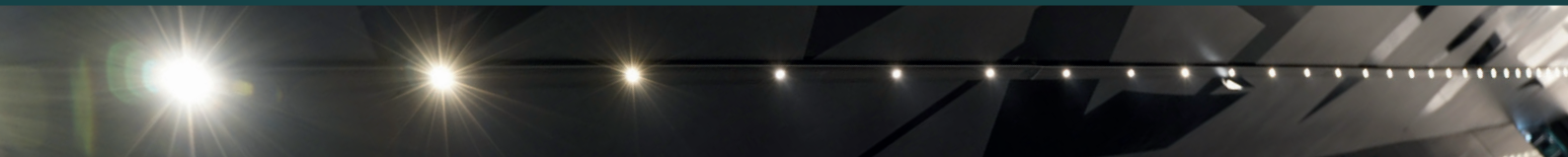

Multiple applications



96.6% can be recycled

Linear solution

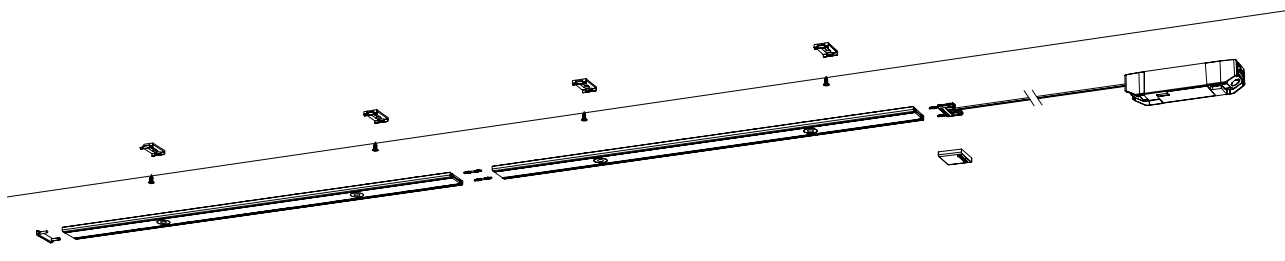

Corner solution

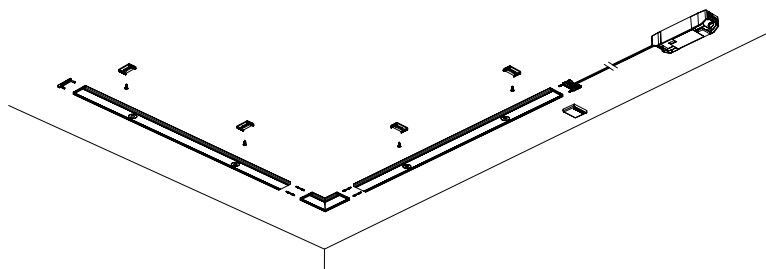

Separated solution

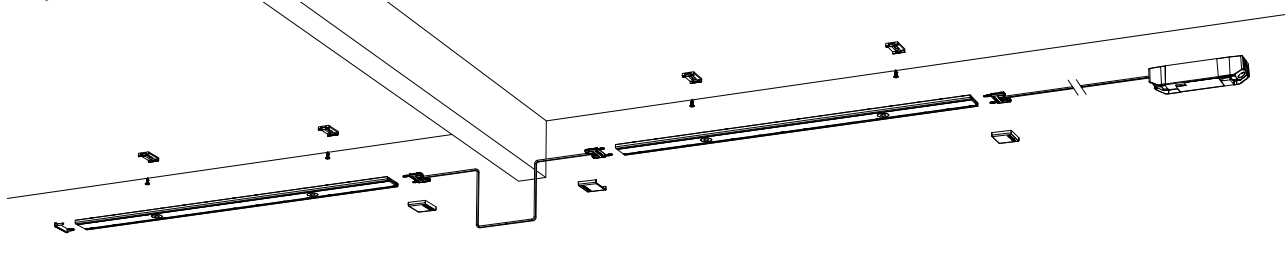

Cut to size

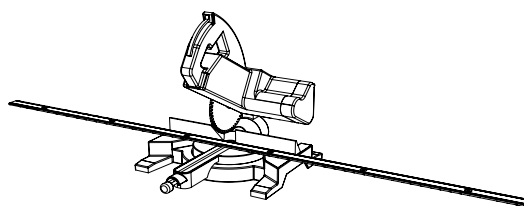

SPECIFICATIONS

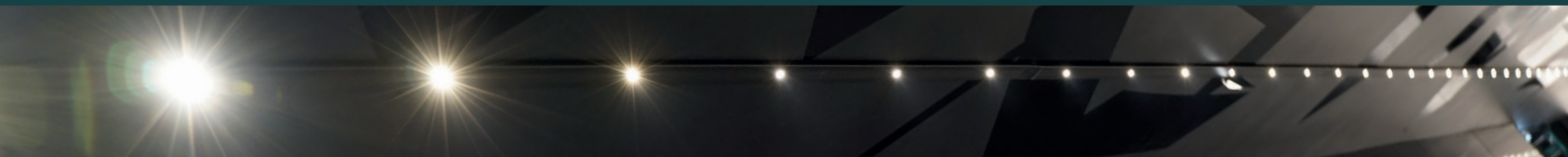

Light Distribution

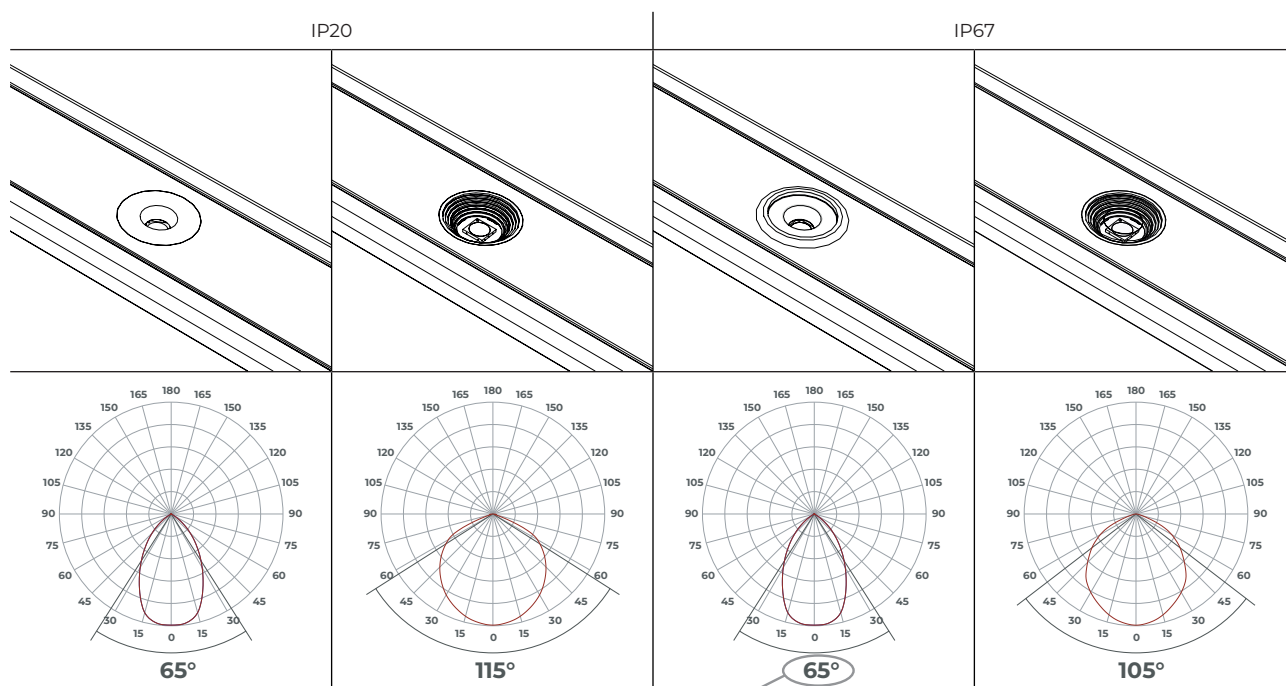

Order code example: TRACY 24V 1800-6-IP67-930-65

Electrical

Voltage range	24 VDC
Power consumption	1,5 W / LED spot (max 3,6 W)
Dimmable	Yes
Ingress protection	IP20 or IP67

Conformity

Marking	CE
RoHS compliant	Yes
REACH complaint	Yes

Photometric

Luminous flux	200 lm / LED spot (max 470 lm)
Luminaire efficacy	135 lm/W (up to 157 lm/W)
Corelated color temperature	3000 K or 4000 K
Color rendering index	+90

Lifetime

L80 @ta 25°C	50.000 hrs
--------------	------------

SPECIFICATIONS

LED driver options



TRACY PSU 25W
Art no. 30030

Mains	220-240 VAC 50/60 Hz
Output power	25 W
LED spot range*	3 - 17
Dimming	DALI, PUSH
IP rating	IP20



TRACY PSU 34W
Art no. 30056

Mains	220-240 VAC 50/60 Hz
Output power	34 W
LED spot range*	8 - 22
Dimming	DALI, PUSH
IP rating	IP20



TRACY PSU 75W
Art no. 30057

Mains	220-240 VAC 50/60 Hz
Output power	75 W
LED spot range*	up to 51
Dimming	-
IP rating	IP65



TRACY PSU 150W
Art no. 30058

Mains	220-240 VAC 50/60 Hz
Output power	150 W
LED spot range*	up to 101
Dimming	-
IP rating	IP65

*LED spot range depends on LED spot configuration

Accessories

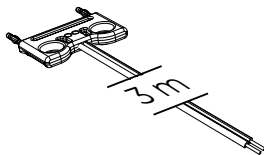

Power cord
Art no.: 30059-01
3000 x 37 x 5.8 mm

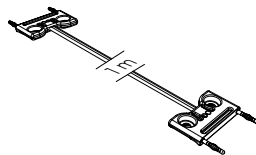

Link cord
Art no.: 30059-01
1000 x 37 x 5.8 mm

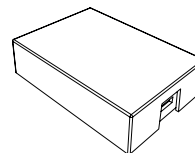

Cord connection box
Art no.: 10230
52 x 36 x 13 mm

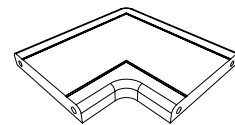

C connector
v51506-D02
58 x 58 x 6 mm



Connector pin
Art no.: 51008-D09
26 x Ø2 mm

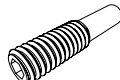

Connector socket
Art no.: 51008-D0618 x Ø4 mm

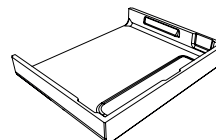

Power cord cover
Art no.: 51008-D47
32 x 40 x 6 mm

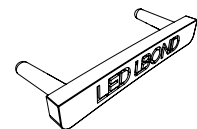

Endcap
Art no.: 51008-D49
16 (3.3) x 40 x 6 mm

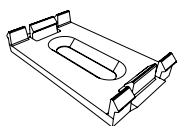

Mounting clip
Art no.: 51008-D66
20 x 37 x 6 mm

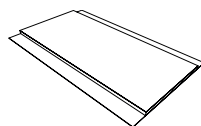

Tape pad
Art no.: 10030
19 x 42 x 1 mm

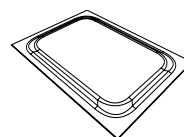

Surface cleaner
Art no.: 10029
59 x 80 x 3 mm

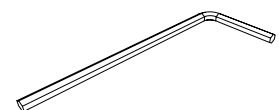

Allen key
Art no.: 10031
51 x 19 x 2 mm

LED iBond A/S
Agern Allé 5A
2970 Horsholm
Denmark

www.ledibond.com
sales@ledibond.com

Made in Denmark